

# EXLW OCS DATASHEET



**MODEL 2**  
12 DC In, 6 Relay Out, 4 - 12-bit Analog In

## 1 TECHNICAL SPECIFICATIONS

### 1.1 General Specifications

Required Power (Steady State)	420mA @ 12VDC 230mA @ 24VDC
Required Power (Inrush)	25A for < 1ms @ 24VDC, DC switched
Primary Power Range	10 - 30VDC
Relative Humidity	5 to 95% non-condensing
Typical Power Backlight 100%	6.816W @ 24VDC
Power Backlight 50%	6.169W @ 24VDC
Power Backlight OFF	5.472W @ 24VDC
Clock Accuracy	+ / - 20 ppm maximum at 25°C (+/- 1 min/month)
Real Time Clock	Battery Backed, Rechargeable Lithium
Operating Air Temp	-10°C to +60°C
Storage Temp	-20°C to +60°C
Weight	1.59 lbs (721.2g)
Altitude	Up to 2000m
Rated Pollution Degree	Evaluated for Pollution Degree 2 Rating
Certifications (UL/CE)	<a href="#">North America</a> <a href="#">Europe</a>

### 1.3 Control & Logic

Control Language Support	Advanced Ladder Logic Full IEC 61131-3 Languages Tag-Based Editor
Logic Program Size	2 MB, maximum
Logic Scan Rate	0.04ms/kB
Digital Inputs	2048
Digital Outputs	2048
Analog Inputs	512
Analog Outputs	512
Gen. Purpose Registers	50,000 (words) Retentive 16,384 (bits) Retentive 16,384 (bits) Non-retentive

### 1.2 Connectivity

Serial Ports	1 RS-232 and 1 RS-485 on first Modular Jack (MJ1/2) 1 RS-232 or 1 RS-485 on second Modular Jack
USB mini-B	USB 2.0 (480MHz) Programming & Data Access
USB A (500mA max)	USB 2.0 (480MHz) for USB flash drives (2TB)
CAN Port Isolated 1kV	Remote I/O, Peer-to-peer Comms, Cscape
CAN Protocols	CsCAN, CANopen, DeviceNet, J1939
Ethernet	10/100 Mb (Auto-MDX)
Ethernet Protocols	TCP/IP, Modbus TCP, FTP, SMTP, EGD, ICMP, ASCII, Cscape, Ethernet IP
Remote I/O	SmartRail, SmartStix, SmartBlock, SmartMod
Removable Memory	microSD, SDHC, SDXC IN FAT32 format, support for 32GB max. Application Updates, Datalogging, and more

### 1.4 User Interface

Display Type	7" TFT Color
Resolution	800 x 480
Color	16-bit (65,536)
Screen Memory	17MB
User-Program. Screens	1023 max pages; 1023 objects per page
Backlight	LED - 50,000 hour life

### 1.5 High-Speed Inputs

Number of Counters	4
Maximum Frequency	1MHz Max
Accumulator Size	32-bits each
Modes Supported	Totalizer, quadrature, pulse measurement, frequency measurement, set-point controlled outputs

### EXLW User Manual [MAN1256]

- The User Manual includes extensive information on:
- Common %S & %SR Registers
  - Resource Limits

## technical specifications continued...

### 1.6 Digital DC Inputs

Inputs per Module	12 including 4 configurable HSC inputs	
Commons per Module	1	
Input Voltage Range	12VDC / 24VDC	
Absolute Max. Voltage	30VDC Max.	
Input Impedance	10kΩ	
Input Current	Positive Logic	Negative Logic
Upper Threshold	0.8mA	-1.6mA
Lower Threshold	0.3mA	-2.1mA
Max. Upper Threshold	8VDC	
Min. Lower Threshold	3VDC	
OFF to ON Response	1ms	
ON to OFF Response	1ms	
High Speed Counter Max Freq*	1MHz	

\*See I/O info below for detail regarding HSC and PWM

### 1.7 Digital Relay Outputs

Outputs per Module	6 Relay	
Commons per Module	6	
Max. Output Current per Relay	3A @ 250VAC, resistive	
Max. Total Output Current	5A continuous	
Max. Output Voltage	275VAC, 30VDC	
Max. Switched Power	1000VAC, 150W	
Contact Isolation to Ground	1000VAC	
Max. Voltage Drop at Related Current	0.5V	
Expected Life (see below derating chart for detail)	No Load: 5,000,000 Rated Load: 100,000	
Max. Switching Rate	300 CPM at no load 20 CPM at rated load	
Type	Mechanical Contact	
Response Time	One update per ladder scan plus 10ms	

### 1.8 Analog Inputs, Medium Resolution

Number of Channels	4	
Input Ranges	0-10VDC, 0-20mA, 4-20mA	
Safe Input Voltage Range	-0.5V to 12V	
Input Impedance (clamped @ -0.5VDC to 12VDC)	Current Mode: 100Ω Voltage Mode: 500kΩ	
Nominal Resolution	12 Bits	
%AI Full Scale	0V, 20mA, 100mV: 32,000 counts full scale	
Max. Over Current	35mA	
Conversion Speed	Once per Ladder Scan	
Max Error at 25°C (excluding Zero) Adjusting Filtering may Tighten	4-20mA 1.00% 0-20mA 1.00% 0-10VDC 1.50%	
Filtering	160Hz Hash (noise) Filter, 1-128 Scan Digital Running Average Filter	

## 2 CONTROLLER OVERVIEW

### 2.1 - Overview of EXLW

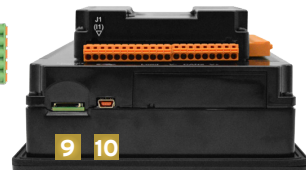
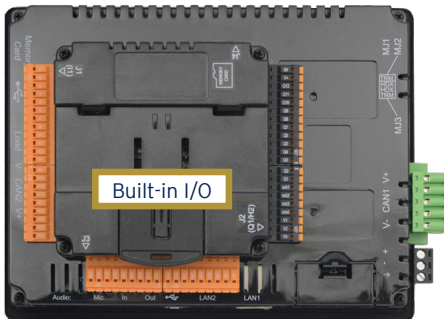
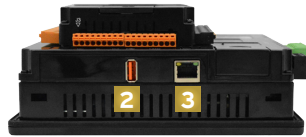

1. Touchscreen
2. USB 2.0 "A": Flash Drive
3. LAN Port
4. PWR: 10-30VDC In
5. CAN Port
6. MJ3: RS-232/485
7. Dip Switches
8. MJ1/MJ2: RJ45 Serial Port
9. microSD: Data Storage
10. USB mini "B": Programming

### 2.2 - Power Wiring

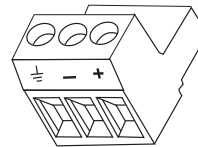

#### Primary Power Port Pins

PIN	SIGNAL	DESCRIPTION
1	Ground	Frame Ground
2	DC-	Input Power Supply Ground
3	DC+	Input Power Supply Voltage

#### DC Input / Frame

Solid/Stranded Wire: 12-24 awg (2.5-0.2mm).

Strip length: 0.28" (7mm).

Torque, Terminal Hold-Down Screws: 4.5 - 7 in-lbs (0.50 - 0.78 N-m).

DC- is internally connected to I/O V-, but is isolated from CAN V-.

A Class 2 power supply must be used.

#### POWER UP

1. OPTION: Attach ferrite core with a minimum of two turns of the DC+ and DC- signals from the DC supply that is powering the controllers.
2. Connect to earth ground.
3. Apply recommended power.



NOTE: See Precaution #12 on page 6 about USB and grounding.

page 2 of 7

controller overview continued on next page...

### 3 WIRING: INPUTS AND OUTPUTS

### wiring: I-O continued...

#### 3.1 - Digital Input

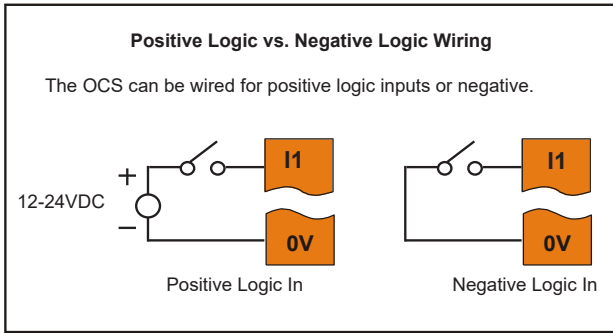

#### DIGITAL INPUTS

Digital inputs may be wired in either a Positive Logic or Negative Logic fashion as shown. The setting in the Cscape Hardware Configuration for the Digital Inputs must match the wiring used in order for the correct input states to be registered. When used as a normal input and not for high speed functions, the state of the input is reflected in registers %I1 - %I12.

Digital inputs may alternately be specified for use with High Speed Counter functions, also found in the Hardware Configuration for Digital Inputs. Refer to the EXLW User Manual (MAN1256) for full details.

#### 3.2 - Relay Out

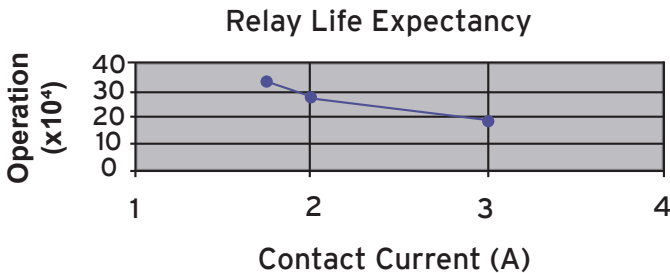

**WARNING:** Exposure to some chemicals may degrade the sealing properties of materials used in the Tyco relay PCJ.

Cover/Case & Base: Mistubishi engineering Plastics Corp.  
5010GN6-30 or 5010GN6-30 M8 (PBT)

Sealing Material: Kishimoto 4616-50K (1 part epoxy resin)  
It is recommended to periodically inspect the relay for any degradation of properties and replace if necessary.

#### 3.3 - Analog Input

Raw input values for channels 1-4 are found in the registers as Integer-type data with a range from 0 - 32000.

Analog inputs may be filtered digitally with the Filter Constant found in the Cscape Hardware Configuration for Analog Inputs. Valid filter values are 0 - 7 and act according to the following chart.

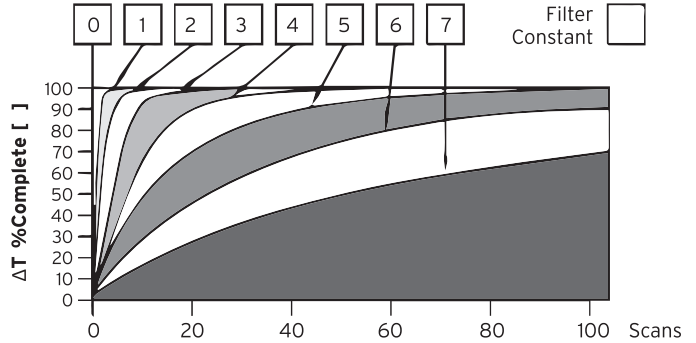

Data Values	
INPUT MODE:	DATA FORMAT, 12-bit INT:
0-20mA, 4-20mA	0-32000
0-10V	0-32000

#### 3.4 - Jumper Settings

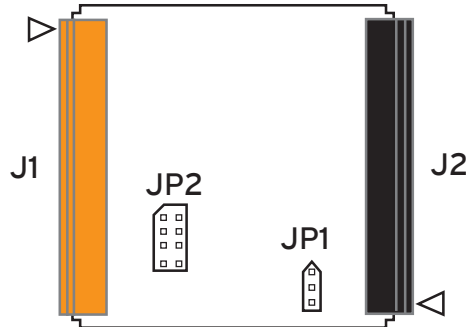

Location of I/O jumpers (JP1 & JP2) and wiring connectors (J1 & J2) with back cover removed.

#### JP1 Digital DC IN/ HSC

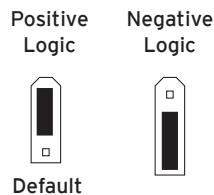

#### JP2 Analog In (A1 - A4)

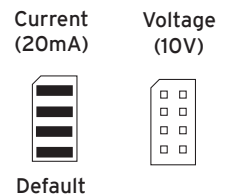

**NOTE:** The Cscape Module Configuration must match the selected I/O (JP) jumper settings. (Cscape Path: Controller > Hardware Configuration > Local I/O > Config > Module Setup > Analog In)

**NOTE:** When using JP2 (A1-A4), each channel can be independently configured.

**Back Panel Torque Rating for EXLW:** 3.0 - 3.5 in-lbs (0.34 - 0.40 N-m)

wiring: I-O continued on next page...

## wiring: I-O continued...

### 3.5 - Wiring Connectors

#### Digital In / Analog In J1 Wiring

J1 (Orange) Name	
I1 (%I1)	Digital In 1
I2 (%I2)	Digital In 2
I3 (%I3)	Digital In 3
I4 (%I4)	Digital In 4
I5 (%I5)	Digital In 5
I6 (%I6)	Digital In 6
I7 (%I7)	Digital In 7
I8 (%I8)	Digital In 8
H1 (%I9)	HSC1 / Dig In. 9
OV	Common
A1 (%AI1)	Analog In 1
A2 (%AI2)	Analog In 2
A3 (%AI3)	Analog In 3
A4 (%AI4)	Analog In 4
OV	Common

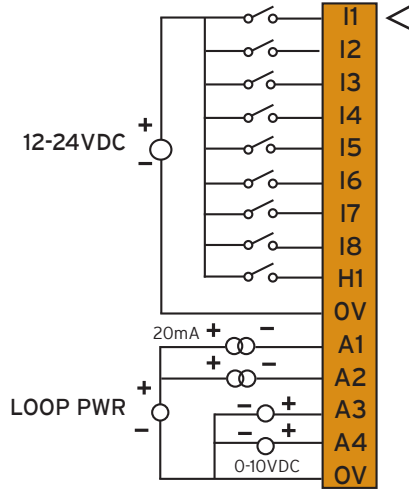

NOTE: The OV terminals are internally connected.

#### Relay Out / Analog Digital In J2 Wiring

J2 (Black) Name	
C6 (%Q6)	Relay 6 COM
R6 (%Q6)	Relay 6 NO
C5 (%Q5)	Relay 5 COM
R5 (%Q5)	Relay 5 NO
C4 (%Q4)	Relay 4 COM
R4 (%Q4)	Relay 4 NO
C3 (%Q3)	Relay 3 COM
R3 (%Q3)	Relay 3 NO
C2 (%Q2)	Relay 2 COM
R2 (%Q2)	Relay 2 NO
C1 (%Q1)	Relay 1 COM
R1 (%Q1)	Relay 1 NO
H4 (%I12)	HSC4 / Dig. In 12
H3 (%I11)	HSC3 / Dig. In 11
H2 (%I10)	HSC2 / Dig. In 10

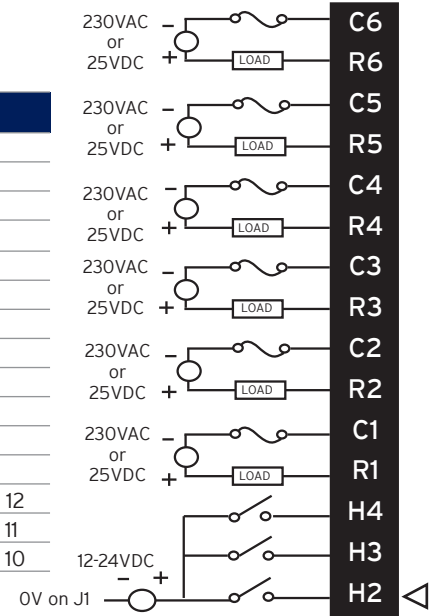

## 4 COMMUNICATIONS

### 4.1 - CAN Communications

#### 20mA Analog In - Not Self Powered

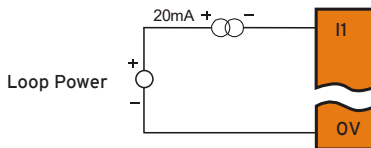

#### 20mA Analog In - Self Powered

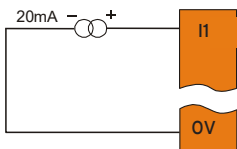

#### 0-10VDC IN

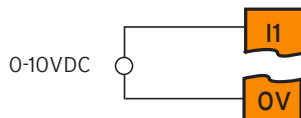

#### CAN Pin Assignments

PIN	SIGNAL	DESCRIPTION
1	V-	CAN Ground - Black
2	CN L	CAN Data Low - Blue
3	SHLD	Shield Ground - None
4	CN H	CAN Data High - White
5	V+ (NC)	No Connect - Red

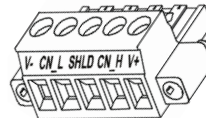

Solid/Stranded Wire: 12-24 awg (2.5-0.2mm)

Strip Length: 0.28" (7mm)

Locking spring-clamp, two-terminators per conductor

Torque, Terminal Hold-Down Screws: 4.5 - 7 in-lbs (0.50 - 0.78 N-m)

V+ pin is not internally connected, the SHLD pin is connected to Earth ground via a 1MΩ resistor and 10 nF capacitor.

### 4.2 - Ethernet Communications

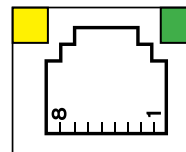

Green LED indicates link - when illuminated, data communication is available.

Yellow LED indicates activity - when flashing, data is in transmission.

## communications continued...

### 4.3 - Serial Communications

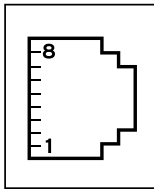

#### MJ1/2 SERIAL PORTS

Two Serial Ports on One Module Jack (8posn)

MJ1: RS-232 w/Full Handshaking

MJ2: RS-485 Half-Duplex

MJ1 PINS			MJ2 PINS	
PIN	SIGNAL	DIRECTION	SIGNAL	DIRECTION
8	TXD	OUT	--	--
7	RXD	IN	--	--
6	0V	GROUND	0V	GROUND
5	+5V @ 60mA	OUT	+5V @ 60mA	OUT
4	RTS	OUT	--	--
3	CTS	IN	--	--
2	--	--	RX- / TX-	IN / OUT
1	--	--	RX+ / TX+	IN / OUT

#### MJ3 PINS

#### MJ3 SERIAL PORT

2 Multiplexed Serial Ports on One Modular Jack (8posn)

PIN	SIGNAL	DIRECTION
8	TXD RS232	OUT
7	RXD RS232	IN
6	0V	GROUND
5	+5V @ 60mA	OUT
4	TX- RS485	OUT
3	TX+ RS485	OUT
2	RX- RS485	IN
1	RX+ RS485	IN

Attach optional ferrite core with a minimum of two turns of serial cable. See website for more details. [Part #: HE-FBD001]

### 4.4 - Dip Switches

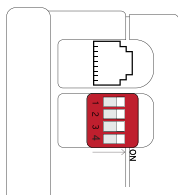

DIP SWITCHES			
PIN	NAME	FUNCTION	DEFAULT
1	MJ3 RS485 Termination	ON = Terminated	OFF
2	MJ3 Duplex	ON = Half	OFF
3		OFF = Full	OFF
4	MJ2 RS485 Termination	ON = Terminated	OFF

The DIP switches are used to provide a built-in termination to both the MJ1, MJ2 & MJ3 ports if needed. The termination for these ports should only be used if this device is located at either end of the multidrop/daisy-chained RS-485 network.

## 5 BUILT-IN I/O for Model 2

All EXLW models (except Model 0) feature built-in I/O. The I/O is mapped into OCS Register space, in three separate areas - Digital/Analog I/O, High-Speed Counter I/O, and High-speed Output I/O. Digital/Analog I/O location is fixed starting at 1, but the High-Speed Counter and High-Speed Output references may be mapped to any open register location. For more details, see the EXLW OCS User's Manual [MAN1256].

#### Digital and Analog I/O Functions

Digital Inputs	%I1-12
Reserved	%I13-32
ESCP Alarm	n/a
Digital Outputs	%Q1-6
Reserved	%Q7-24
Analog Inputs	%A1-4
Reserved	%A15-12
Analog Outputs	n/a
Reserved	n/a

## 6 ANALOG IN TRANZORB FAILURE

A common cause of Analog Input Tranzorb Failure on Analog Inputs Model 2, 3, 4 & 5: If a 4- 20mA circuit is initially wired with loop power, but without a load, the Analog input could see 24VDC. This is higher than the rating of the tranzorb. This can be solved by NOT connecting loop power prior to load connection, or by installing a low-cost PTC in series between the load and Analog input.

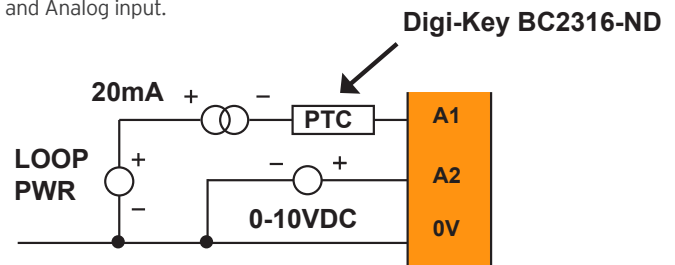

#### Wiring Details:

Solid/Stranded Wire: 12-24 awg (2.5-0.2mm<sup>2</sup>).

Strip Length: 0.28" (7mm).

Torque, Terminal Hold-Down Screws: 4.5 - 7 in-lbs (0.50 - 0.78 N-m).

## 7 DIMENSIONS & INSTALLATION

### 7.1 - Dimensions

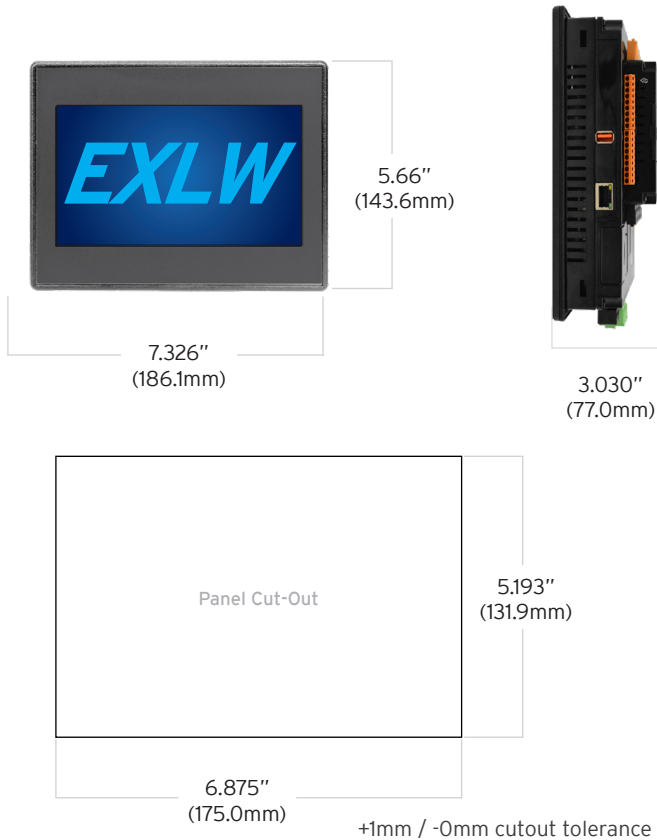

### 7.2 - Installation Procedure

- The EXLW utilizes a clip installation method to ensure a robust and watertight seal to the enclosure. Please follow the steps below for the proper installation and operation of the unit.
  - This equipment is suitable for Class I, Division 2, Groups A, B, C and D or non-hazardous locations only.
  - Digital outputs shall be supplied from the same source as the operator control station.
  - Jumpers on connector JP1 shall not be removed or replaced while the circuit is live unless the area is known to be free of ignitable concentrations of flammable gases or vapors.
1. Carefully locate an appropriate place to mount the EXLW. Be sure to leave enough room at the top of the unit for insertion and removal of the microSD™ card.
  2. Carefully cut the host panel per the diagram, creating a 131.9mm x 175.0mm +1mm/-0mm panel cutout tolerance, opening into which the EXLW may be installed. If the opening is too large, water may leak into the enclosure, potentially damaging the unit. If the opening is too small, the OCS may not fit through the hole without damage.
  3. Remove any burrs and or sharp edges and ensure the panel is not warped in the cutting process.
  4. Remove all Removable Terminals from the EXLW. Insert the EXLW through the panel cutout (from the front). The gasket must be between the host panel and the EXLW.
  5. Install and tighten the four mounting clips (provided in the box) until the gasket forms a tight seal  
**NOTE: Max torque is 0.8 to 1.13Nm, or 7 to 10 in-lbs.**
  6. Reinstall the EXLW I/O Removable Terminal Blocks. Connect communications cables to the serial port, USB ports, Ethernet port, and CAN port as required.



## 8 SAFETY & WARNINGS

### 8.1 - WARNINGS

1. To avoid the risk of electric shock or burns, always connect the safety (or earth) ground before making any other connections.
2. To reduce the risk of fire, electrical shock, or physical injury, it is strongly recommended to fuse the voltage measurement inputs. Be sure to locate fuses as close to the source as possible.
3. Replace fuse with the same type and rating to provide protection against risk of fire and shock hazards.
4. In the event of repeated failure, do NOT replace the fuse again as repeated failure indicates a defective condition that will NOT clear by replacing the fuse.
5. Only qualified electrical personnel familiar with the construction and operation of this equipment and the hazards involved should install, adjust, operate, or service this equipment. Read and understand this manual and other applicable manuals in their entirety before proceeding. Failure to observe this precaution could result in severe bodily injury or loss of life.
6. **WARNING** - Battery may explode if mistreated. Do not recharge, disassemble, or dispose of in fire.
7. **WARNING - EXPLOSION HAZARD** - Batteries must only be changed in an area known to be non-hazardous.

### 8.2 - FCC COMPLIANCE

This device complies with Part 15 of the FCC Rules. Operation is subject to the following two conditions:

1. This device may not cause harmful interference
2. This device must accept any interference received, including interference that may cause undesired operation

### 8.3 - PRECAUTIONS

All applicable codes and standards need to be followed in the installation of this product. Adhere to the following safety precautions whenever any type of connection is made to the module:

1. Connect the safety (earth) ground on the power connector first before making any other connections.
2. When connecting to the electric circuits or pulse-initiating equipment, open their related breakers.
3. Do NOT make connection to live power lines.
4. Make connections to the module first; then connect to the circuit to be monitored.
5. Route power wires in a safe manner in accordance with good practice and local codes.
6. Wear proper personal protective equipment including safety glasses and insulated gloves when making connections to power circuits.
7. Ensure hands, shoes, and floor are dry before making any connection to a power line.
8. Make sure the unit is turned OFF before making connection to terminals.
9. Make sure all circuits are de-energized before making connections.
10. Before each use, inspect all cables for breaks or cracks in the insulation. Replace immediately if defective.
11. Use copper conductors in Field Wiring only, 60/75°C.
12. Use caution when connecting controllers to PCs via serial or USB. PCs, especially laptops may use "floating power supplies" that are ungrounded. This could cause a damaging voltage potential between the laptop and controller. Ensure the controller and laptop are grounded for maximum protection. Consider using a USB isolator due to voltage potential differences as a preventative measure.

## 9 BACKUP BATTERY

The EXLW has an advanced battery system that uses a rechargeable lithium battery. The battery powers the real time clock when power is removed, and it is needed for register data retention. Please reference the EXLW User Manual [MAN1256] which provides instructions on how to replace the battery.

**NOTE:** For detailed rechargeable battery information, refer to the Battery Manual [MAN1142].

## 10 ACCESSORIES

### 10.1 Backup Battery: HE-BAT019

The EXLW uses a rechargeable 3.6V lithium battery to run the Real-Time Clock and to maintain the retained register values. This battery is designed to maintain the clock and memory for 7-10 years.

### 10.2 Programming Cables Kit: HE-XCK

This programming cable kit includes the following adapter cables:

- USB to MiniUSB
- USB to RS-232 Serial
- RS-232 Serial to RJ45 Ethernet

### 10.3 2/4 Channel Analog Output Kit

- HE-XDAC007 - 2 Channel Analog Output I/O Kit
- HE-XDAC107 - 4 Channel Analog Output I/O Kit

Visit the Horner Website to purchase accessories.

## 11 PART NUMBER

	North America	Europe
Model 2	HE-EXLWE2	HEXT381C112

## 12 TECHNICAL SUPPORT

For assistance and manual updates, contact Technical Support at the following locations:

#### North America

+1 (317) 916-4274  
(877) 665-5666  
[www.hornerautomation.com](http://www.hornerautomation.com)  
techsppt@heapg.com

#### Europe

+353 (21) 4321-266  
[www.hornerautomation.eu](http://www.hornerautomation.eu)  
technical.support@horner-apg.com